



Smart Sensor (Microwave)

- Geschikt voor toepassingen in hoge plafonds (max. detectiehoogte 13 m)
- Instelbaar detectiebereik voor toepassingen in lage/hoge plafonds



Specificaties

Artikelcode	Artikelomschrijving	Sensor bereik	Brutoprijs
560000008400	LEDsmartlight-Rc-MW-Sensor	20 m	€ 139,00

Accessoires



IP20

560098000600 (€ 34,00)
LEDsmart-Sensor Surface-Module-WH



IP65

560006000900 (85,00)
LEDsmart-Sensor IP65-Base-Module
Excluding sensor



IP65

560006001000 (75,00)
LEDsmart-Sensor IP65-Module
Excluding sensor

Maatschets (mm)

560098000600 LEDsmart-Sensor Surface-Module-WH

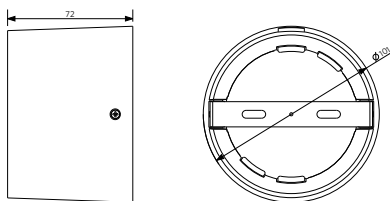

560006000900 LEDsmart-Sensor IP65-Base-Module

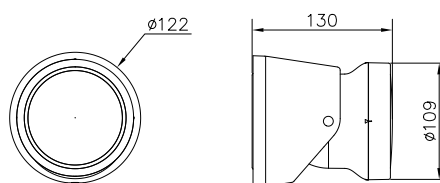

560006001000 LEDsmart-Sensor IP65-Module

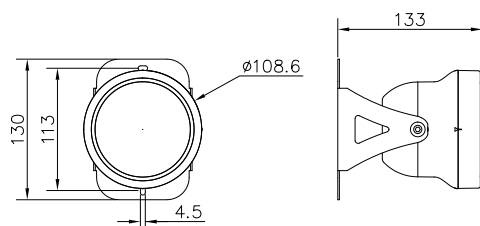

560000008400 LEDsmartlight-Rc-MW-Sensor

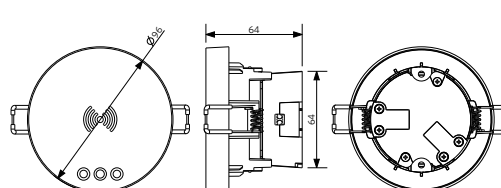

Technische specificaties	
IP-klasse	IP20 / IP65*
IK-klasse	IK02
Afwerking	Wit RAL9003
Communicatie	Opplé Bluetooth® Low Energy Mesh
Beschermingsklasse	II
Detectiegebied (bij montagehoogte van 2.5-13m)	Max Ø 20m
Detectiehoek	360°
Detectietechniek	Microwave (MW)
Nalooptijd	1min-60min
Daglichtregeling	Ja
Temperatuursensor	Ja
Luchtvochtigheidssensor	Ja

Elektrische aansluiting	
Stroomverbruik	2.2W
Input spanning	220-240 V AC
Frequentie	50/60 Hz



Materiaal eigenschappen	
Materiaal behuizing	PC

Toepassingscondities	
Bedrijfstemperatuur	-30-55C

* IP65 uitsluitend in combinatie met IP65-accessoiremodules

Detectie bereik

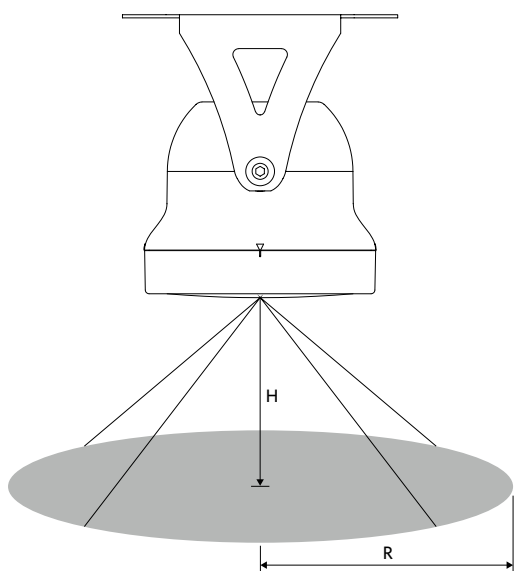

Tekening inbouwmaat (mm)

LEDSmartlight-Rc-MW-Sensor

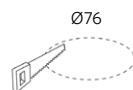

Aanbevolen hoogte (m)	Gevoeligheidsinstelling	Detectiegebied (m)
3	Low	7
8	Middle	9
9	High	10
12	High	7

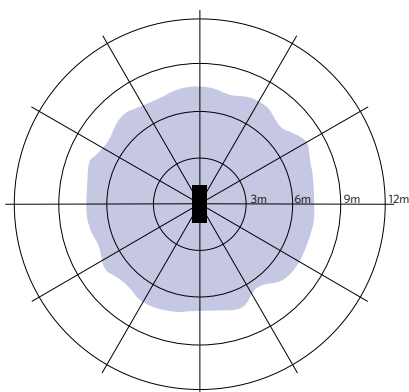

Installation - Low Ceiling
Suggested installation height 3m

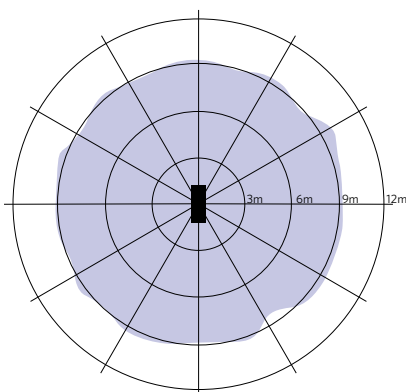

Installation - Medium Ceiling
Suggested installation height 8m

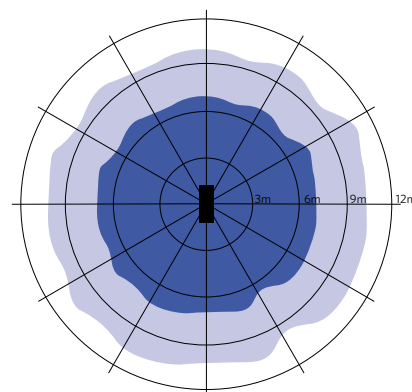

Installation - High Ceiling
Suggested installation height 9-12m