











- Premium side-lit LED Slim Panel, suitable for offices (UGR19)
- Ultra-slim panel (9mm), ideal for suspended use
- Recessed, suspended and surface mounting possible



Specifications

Item Code	Item Description	Equivalent to (W)	Power (W)	Lumen	Efficacy (lm/W)	CCT (K)	Colour rendering index (CRI)	Weight (kg/pc)
DALI2								
542004069000	LEDPanelRc-S5 Sq595-30W-DALI-840-U19	TL 4x18W	30	3900	130	4000	> 80	2.49

Accessories

Surface Mounting Frame		Recessed Mounting Frame				
						
140055484 LEDPanelRc-SI Sq600-Surface-Module-WH-CT	542098017600 LEDPanelRc2 Sq600-Surface-Kit-WH	542098009600 LEDPanelRc Sq600-Frame-WH	140057770 LEDPanelRc-SI-Mounting-Springs-595	542098006900 LEDPanel-S4-Suspension-Kit	542098000800 LEDPanelRC-SI U19 EM-kit 1h	
					542098000900 LEDPanelRC-SI U19 EM-kit 3h	
						
140060852 LEDFixture-Ceiling-Cable-Kit-0.5m	542098030700 Junction-Box-WH					

Packaging Information

Item			Box			
Item Code	Item Description	EU HS Code	Dimensions (mm) (LxWxH)	Gross Weight (kg)	EAN	pc/box
542004069000	LEDPanelRc-S5 Sq595-30W-DALI-840-U19	94051190	661x695x46	3.57	6941497735829	1
140055484	LEDPanelRc-SI Sq600-Surface-Module-WH-CT	94059900	690x690x118	4.26	6956321879808	1
140057770	LEDPanelRc-SI-Mounting-Springs-595	73209090	80x80x53	0.50	6956321888121	1
140060852	LEDFixture-Ceiling-Cable-Kit-0.5m	73121020	100x100x5	0.40	6956321895266	1
542098000800	LEDPanelRC-SI U19 EM-kit 1h	85044083	490x390x150	0.98	6941497702340	1
542098000900	LEDPanelRC-SI U19 EM-kit 3h	85044083	490x390x150	1.08	6941497702333	1
542098001000	LEDTrunking DALI Power Supply	85044083	198x54x39	0.24	6945730496614	1
542098006900	LEDPanel-S4-Suspension-Kit	73121020	130x130x30	0.22	6941497701428	1
542098009600	LEDPanelRc Sq600-Frame-WH	94059900	688x88x694	1.79	6941497704061	1
542098017600	LEDPanelRc2 Sq600-Surface-Kit-WH	94059900	685x77x68	1.53	6941497720696	1
542098030700	Junction-Box-WH	85369010	43x103.4x26	0.06	6941408868684	1

Technical Specifications

Lifetime (L70)	100,000 h
Lifetime (L80)	70,000 h
Lifetime (L90)	50,000 h
On-/Off-cycles	100,000
Colour consistency (SDCM)	3
Dimmability	DALI
Beam angle	85°
Finishing	White RAL9003
UGR	≤ 19
IP front side	IP54
IP recessed part	IP20
Impact strength	IK04
Protection class	II
Risk group (EN 62471)	RG0
With control gear	Yes
Glow wire test	650°C
Power factor	≥ 0.9

Electrical Supply

Frequency	50/60 Hz
Nominal voltage	220-240 V
DC input voltage	See catalogue appendix
Connection	Specifications
230V Cable length	1 m

Mechanical Properties

Housing material	Aluminum
Optical material	PMMA
Cover material	Polystyrene (PS)

Ambient Conditions

Operating temperature	-20-+40°C
Application temperature	+25°C
Storage environment	-25-+50°C



ENERGY

OPPLE Lighting
542004069000

A
B
C
D
E
F
G

30
kWh/1000h

2019/2015

Dimensional Drawing (mm)

LEDPanelRc-S5 Sq595

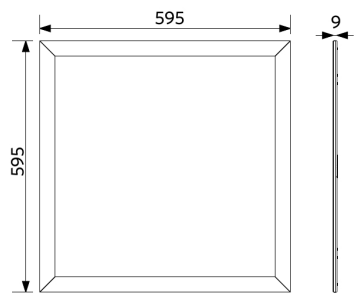

LEDPanelRc-S5 Driver On/Off

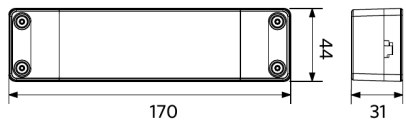

LEDPanelRc-S5 Driver Dim

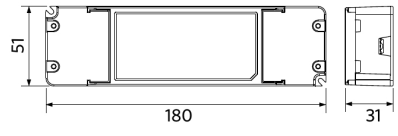

LEDPanelRc-S5 Driver Tunable White

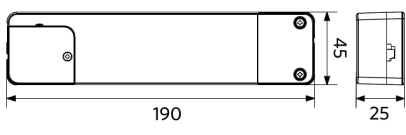

Photometric Data

