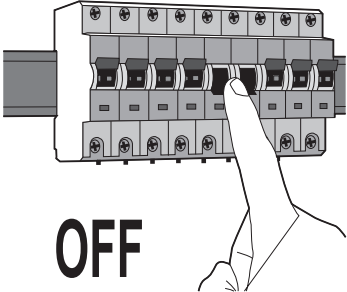

High Power Bulb

Version date 15-05-2017
www.opple.com

Art. Code	Family Name	kg
140062576	HPB	1.379

Retrofit

①  OFF

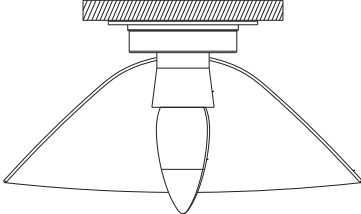
② 
Remove traditional lighting source from E40 lamp holder

③ Direct 220V~240V
Direct wiring circuit diagram of a retrofitted luminaire

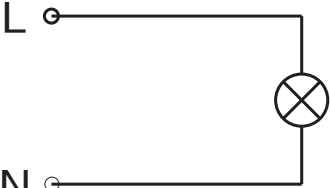

Built in control gears must not remain connected after rewiring

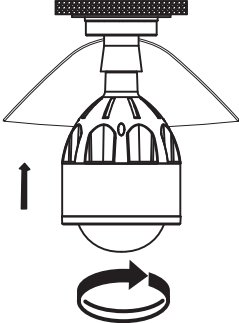
④ 

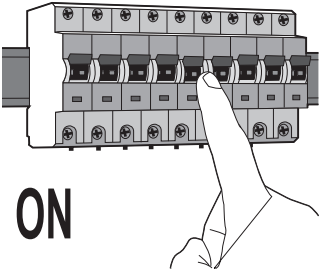
⑤  ON

Hook

①

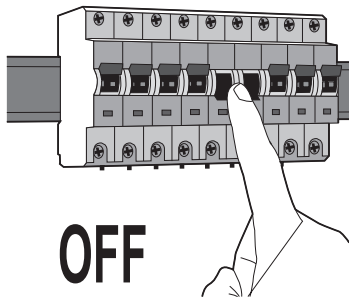

②

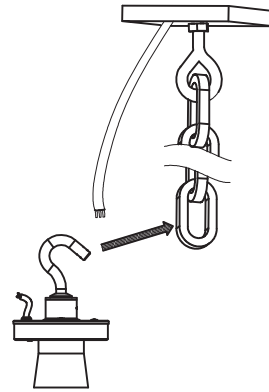

③

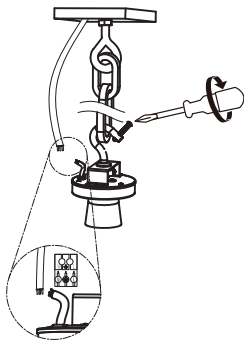

Picture	Specification	Quantity	unit
	M6x40	1	

④



⑤

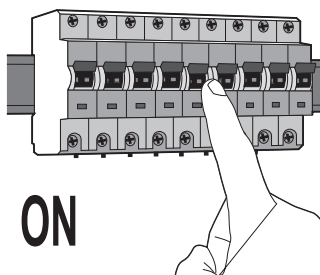

Surface mounting

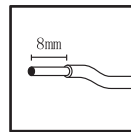
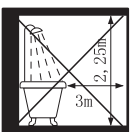
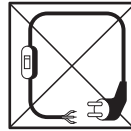
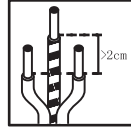
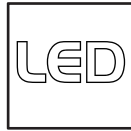
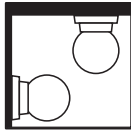
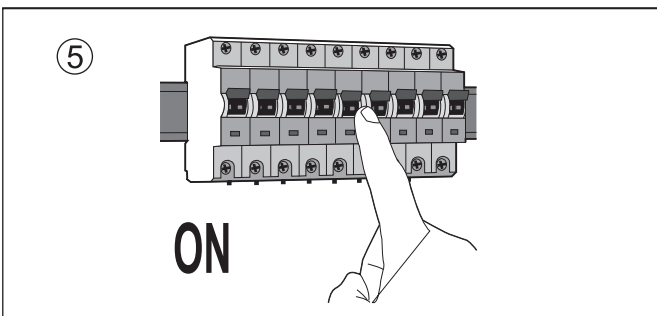
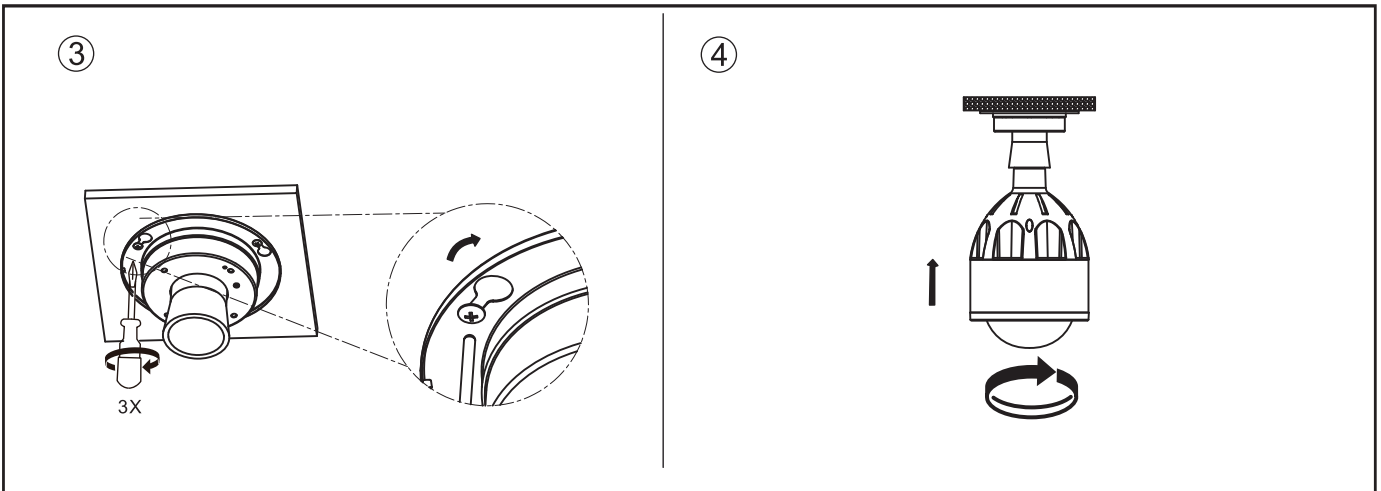
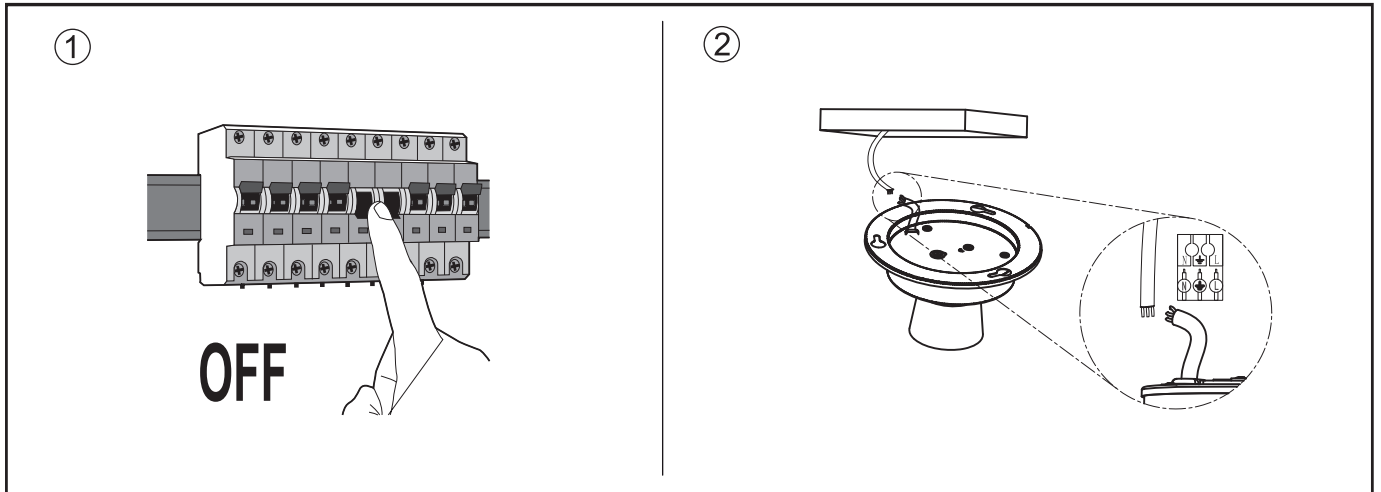

Data subject to change
 Les données sont sujettes à variations
 Änderungen vorbehalten

Opplé Lighting Electronic (Zhongshan) Co., Ltd.
 528422
 Building A, No.275 Dongan Bei Road,
 Haizhou District, Guzhen Town,
 Zhongshan City, Guangdong, China.

OPPLE Lighting B.V.
 Materiaalweg 6-6A
 5681 RJ Best
 The Netherlands
 service@opple.com
 www.opple.com