

High Power Bulb

Art. Code

Family Name



140062577

HPB

1.890

Retrofit

①

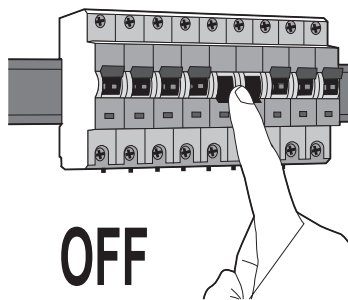

②

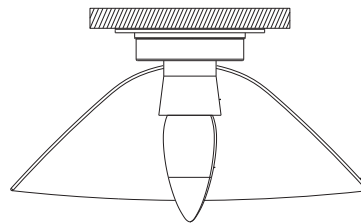

Remove traditional lighting source from E40 lamp holder

③

Direct 220V~240V

Direct wiring circuit diagram of a retrofitted luminaire

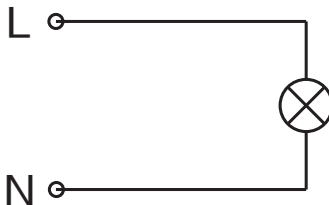

Built in control gears must not remain connected after rewiring

④

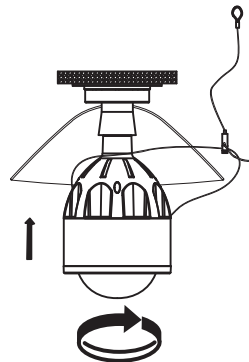

⑤

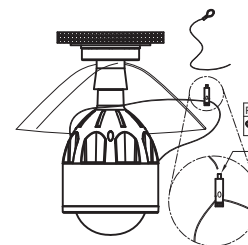

Picture	Specification	Quantity	unit
	φ 1mmx1.2m	1	

⑥

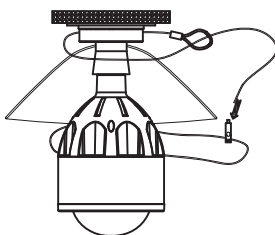

⑦

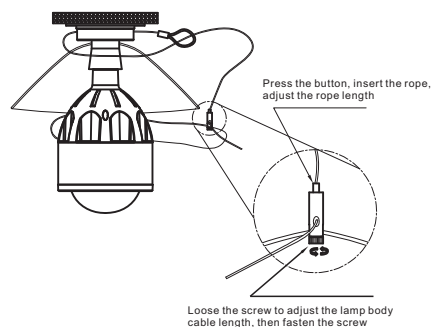

⑧

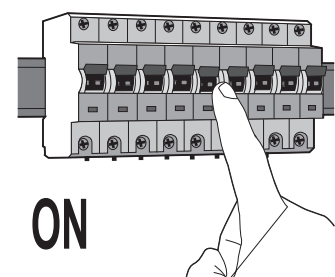

Hook

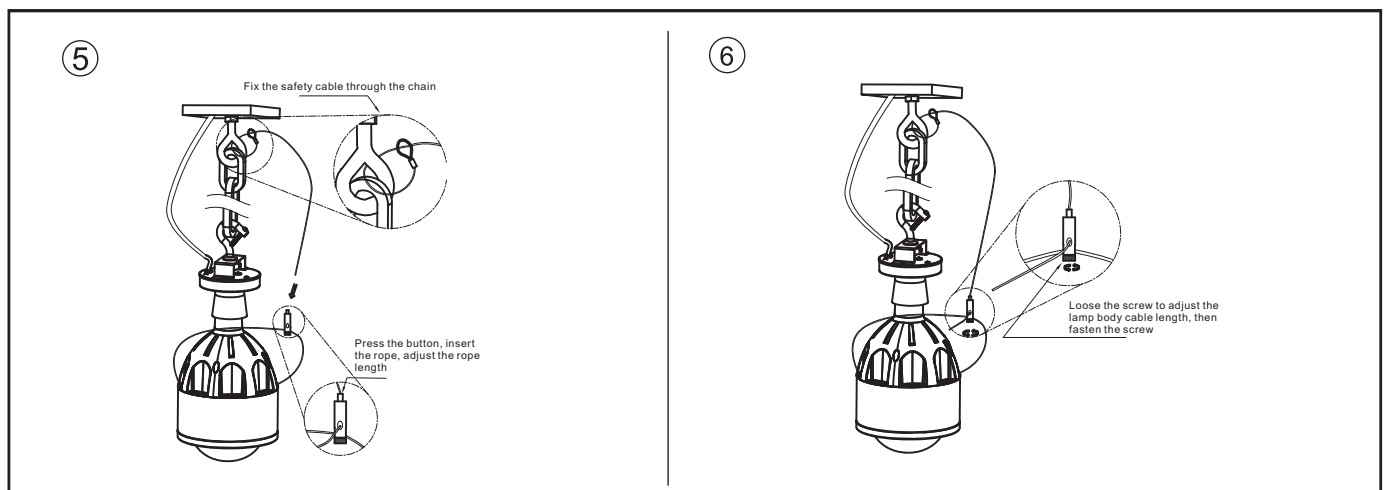
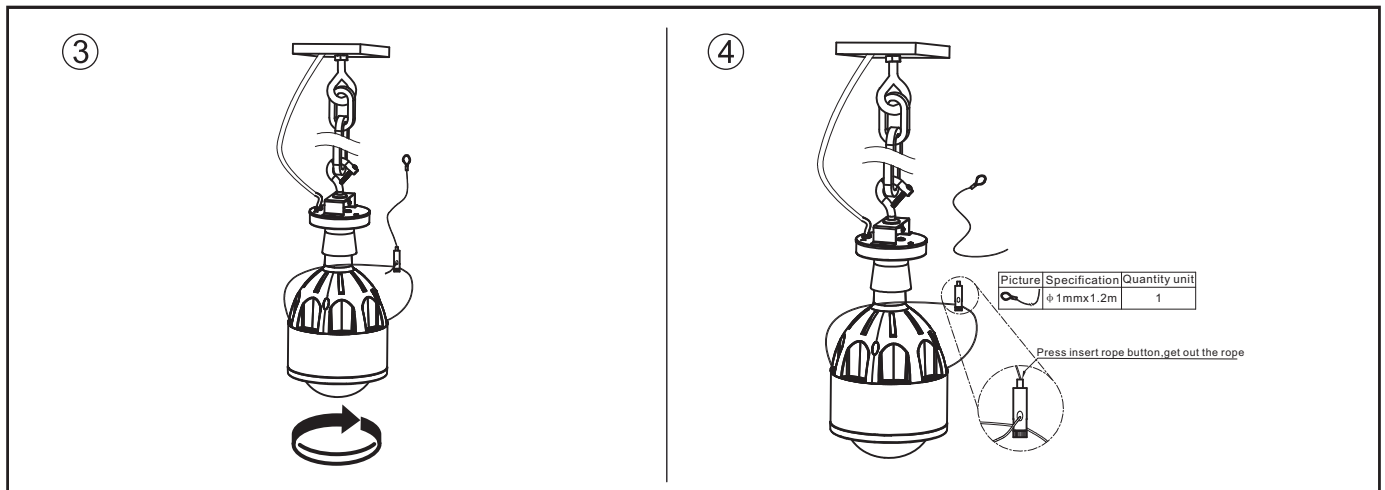
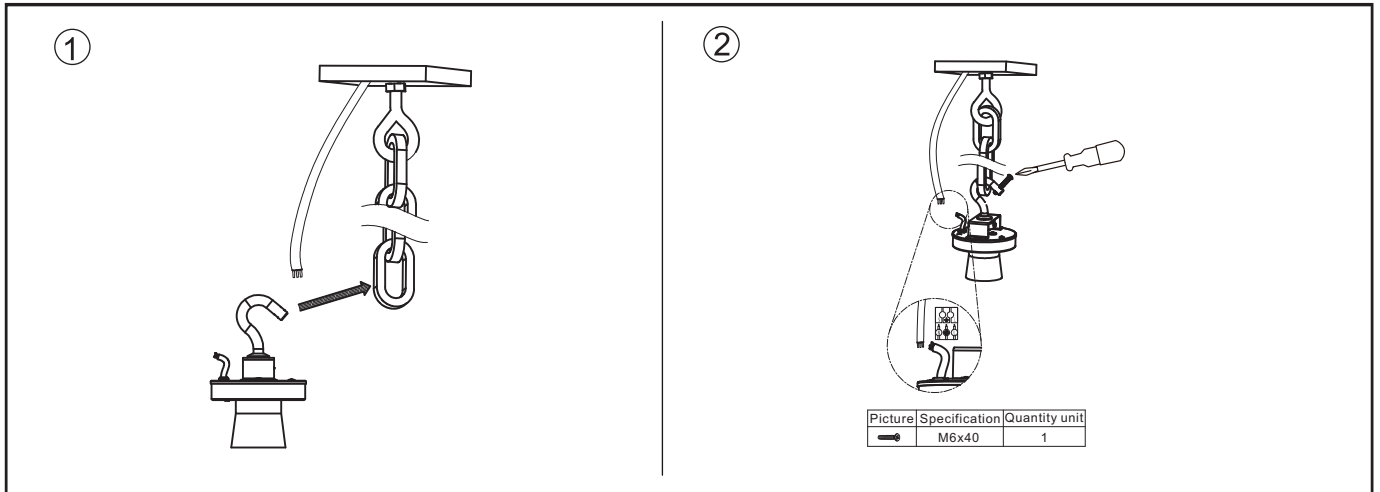

Surface mounting

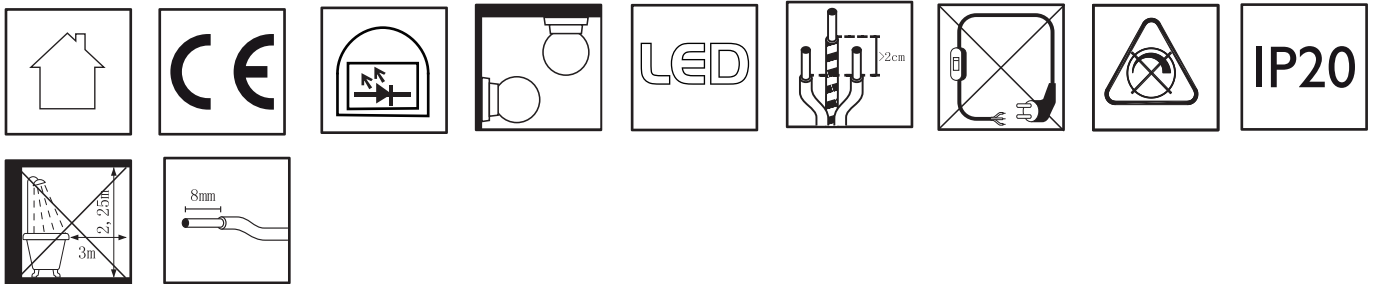
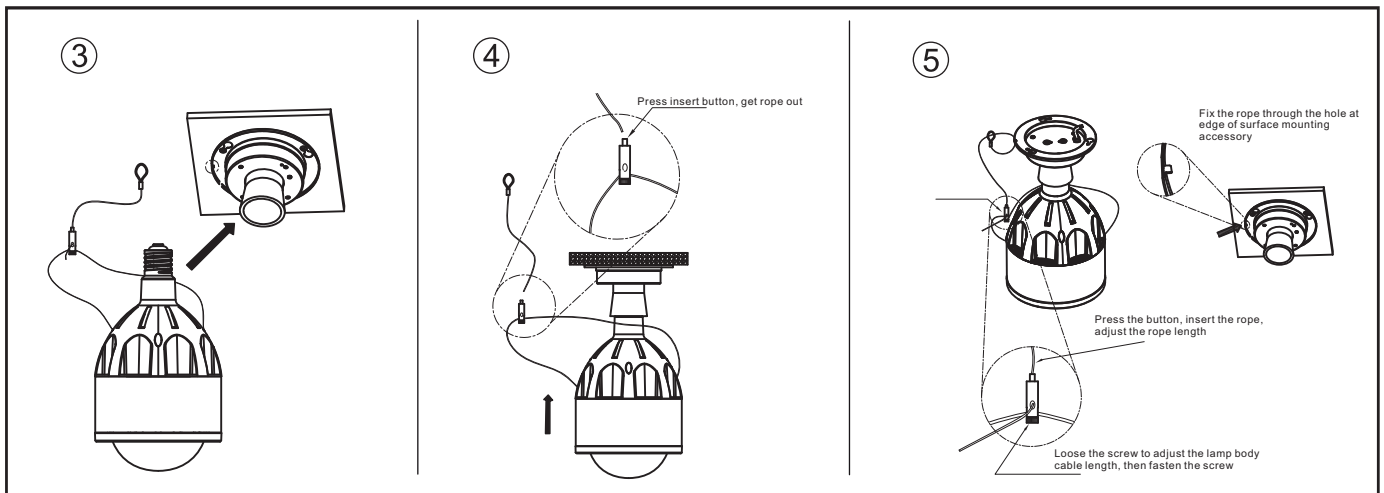
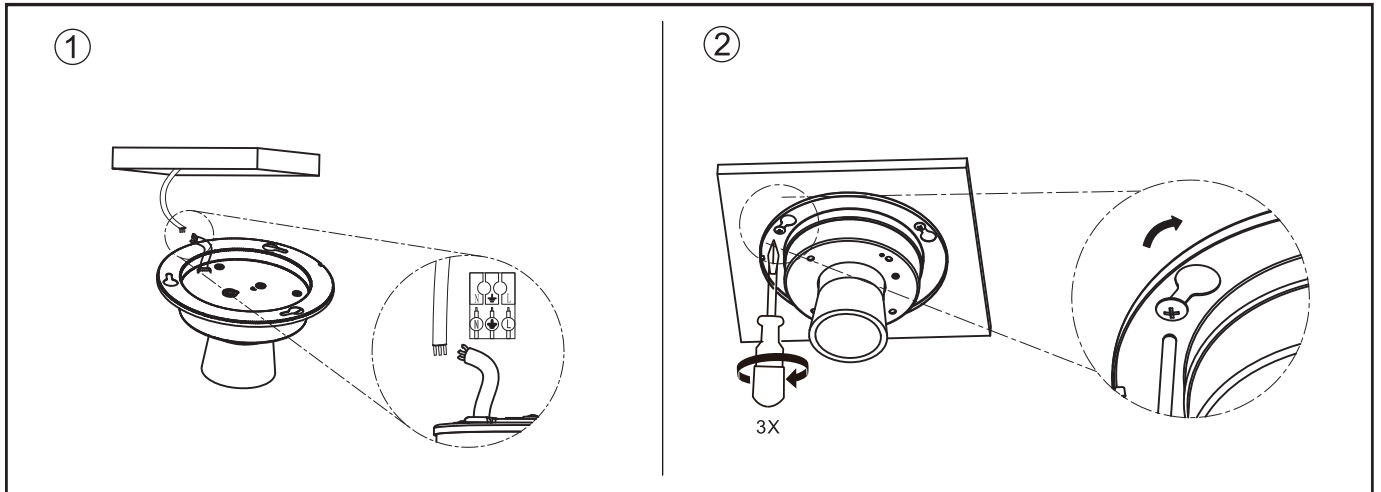

Data subject to change
 Les données sont sujettes à variations
 Änderungen vorbehalten

Opplé Lighting Electronic (Zhongshan) Co., Ltd.
 528422
 Building A, No.275 Dongan Bei Road,
 Haizhou District, Guzhen Town,
 Zhongshan City, Guangdong, China.

OPPLE Lighting B.V.
 Materiaalweg 6-6A
 5681 RJ Best
 The Netherlands
 service@opple.com
 www.opple.com