

LED Floodlight Basic

Item Code	CCT	
543017009900	4000K	1.32Kg
543017010000	4000K	1.57Kg

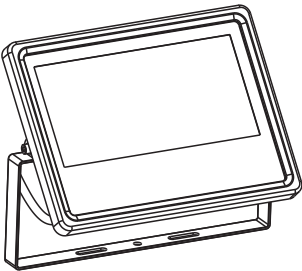

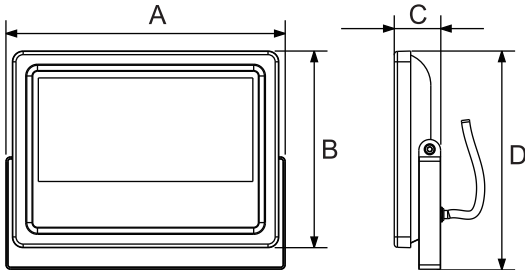

Model	A (mm)	B (mm)	C (mm)	D (mm)	MPA (m ²)
LED FL-B Re217 50W	257	181	44	201	0.0465
LED FL-B Re266 70W	280	193	45	225	0.0540

MPA: Maximum Projected Area Of The Luminaire.

Model	Rated Voltage	Frequency	Rated Power
LED FL-B Re217 50W	220-240V~	50/60Hz	50W
LED FL-B Re266 70W	220-240V~	50/60Hz	70W

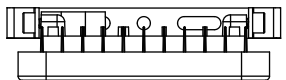

The product can be used in various applications such as warehouses, industrial lots, public areas, building facades, etc.

①

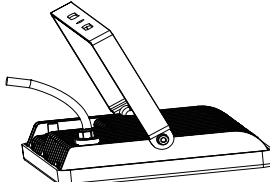

②

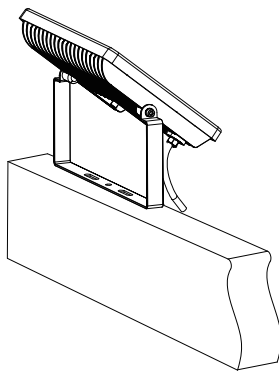

③

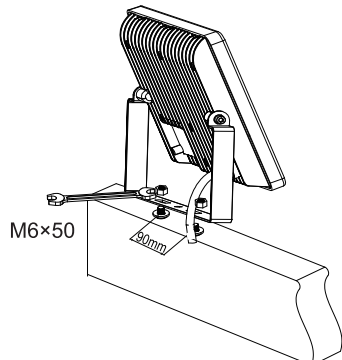

M6x50

④

